

MODEL 19070 SERIES 19050 SERIES

KEY FEATURES

- ACWV/DCWV/IR 3 in 1 hipot tester
- Programmable output voltage to 5kV AC and 6kV DC
- 1kV insulation resistance test
- Insulation resistance measurement from 1M Ω to 50G Ω
- Ground continuity check (GC)
- Standard RS-232 interface
- Open short check(OSC) function
- GFI shutdown of the instrument when current imbalance > 0.5mA
- Flashover (ARC) detection
- Quick discharge of DUT in IR and DC test
- Pause mode
- UL and TUV approved (*see spec.)
- CE mark
- Programmable ramp/fall and test time
- Programmable high/low limit
- Save/Recall program test function
- Remote control and interface support



AC/DC/IR HIPOT TESTER MODEL 19070 & 19050 SERIES

Complete Dielectric Testing Solution

The Chroma 19050 Series electrical safety testers are advanced digital hipot testers with load and line regulations that help ensure measurement integrity. The Multi-step capability allows users to perform multiple tests in sequence, such as AC hipot followed by IR.

The 19050 Series Hipot Testers have 3 models available for selection: the 19052, 19053, and 19054. The 19052 includes AC/DC hipot testing and IR (Insulation Resistance) measurement while the 19053 provides 8 scan channels for AC/DC hipot testing and IR measurement. The 19054 provides 4 scan channels for AC/DC hipot testing and IR measurement in a single compact unit.

The 19070 Series has 2 models available for selection: the 19071 and the 19073. The 19071 is for AC Hipot testing while the 19073 combines both AC/DC hipot with IR measurement into a single compact unit.

Open Short Check (OSC)

The OSC function is used to check whether the connection is an open circuit between the instrument and the DUT or if there is a

breakdown inside the DUT before testing for electrical safety.

Flashover (ARC) Detection

The 19070 and 19050 series are sensitive enough to monitor for current spikes even if they do not exceed the maximum trip current level.

Ground Continuity Check (GC)

All of the 19070 and 19050 series testers have a ground continuity check feature to determine if the resistance between the ground pin of the power cord and any exposed metal on the product is less than 1 Ω .

Ground Fault Interrupt (GFI)

GFI is required by the National Electrical Code in wet locations. Such devices automatically interrupt power when a ground current > 0.5mA exists for more than a few milli-seconds to protect users.

Quick Discharge

For DC hipot and IR tests, the DUT is discharged back through the HV transformer attaining a rapid and safe discharge.



Chroma

MAIN FUNCTIONS

FLASHOVER DETECTION (ARC)

Fast transients in voltage or current during hipot testing are called electrical flashover. Normally, with AC line frequency (50Hz/60Hz) or DC hipot testing, the leakage current is the same 50Hz/60Hz or DC (charge current excepted). As shown in Figure 1, leakage current varies smoothly.

In contrast, when electrical discharge occurs due to poor insulation materials, electrode gaps, surface clearances, etc., fast transients in leakage current become apparent, as shown in Figure 2. Most of the electrical safety regulations state a necessity of withstand strength test. Nevertheless, general hipot testers only detect the RMS value of leakage current without the capability to detect flashover. Therefore, a hipot tester equipped with FLASHOVER detection function is necessary.

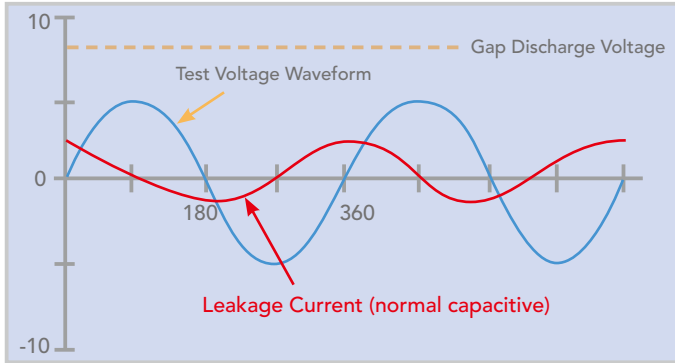

Figure 1 : Normal Leakage Current Waveform

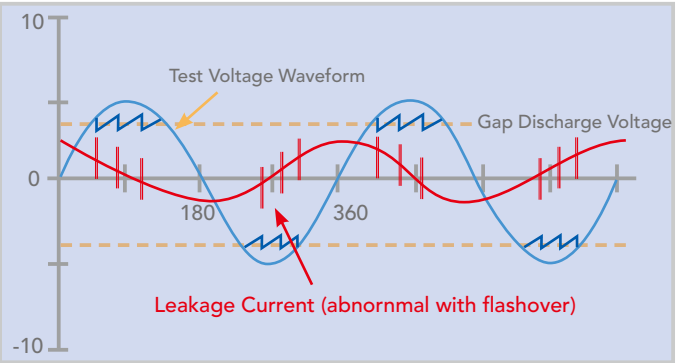
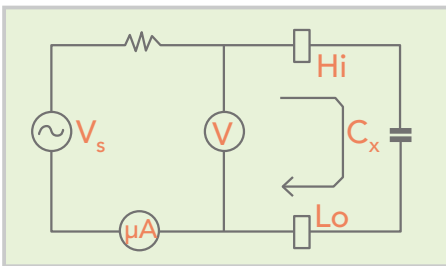

Figure 2 : Leakage Current Waveform when flashover occurred

OPEN/SHORT CHECK (OSC)

The O.S.C function is used to check whether the circuit connection between the instrument and the DUT (equipment under test) is open or shorted before the electrical safety test begins. Without checking for an open or short, it is possible for the connection to be bad due to a bad lead or relay oxidation, but for the tester to still register a PASS. In some cases, the DUT is shorted before testing. Testing a shorted DUT continually leads to instrument failure due to suffering the high load current. Therefore, it is necessary to check the open and short circuit to ensure the test is effective and protects the instruments.

Normally, a DUT has capacitive loads (C_x) from tens to thousands of pF. If the connection is open, the capacitance will appear and its total capacitive load will be lower than that of normal conditions. If the DUT is shorted, the total capacitive load is higher than that of normal conditions. Therefore, we can measure the value of the capacitive load to check whether the contact is good or not.



Normal Condition

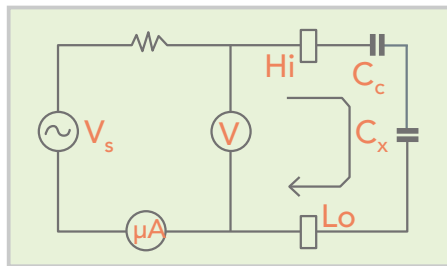

If Circuit Opened :
 $C = C_c * C_x / (C_c + C_x) \ll C_x$

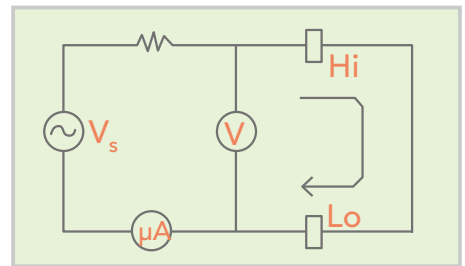

If Circuit Shorted :
 $C \gg C_x$

GROUND FAULT INTERRUPT (GFI)

As requirements for test environments state that the test equipment must be equipped with an auto interrupt device, Chroma has embedded Ground Fault Interrupt (GFI) function in the 19050 and 19070 Series testers. When the current meters A1 and A2 detect difference ($i_2 - i_1 = i_H$) between the values i_1 and the actual i_2 test current is too high, the instrument can cut the power immediately to protect the human body. It is not only compliant with the safety standard but also provides more safeguards for testing personnel.

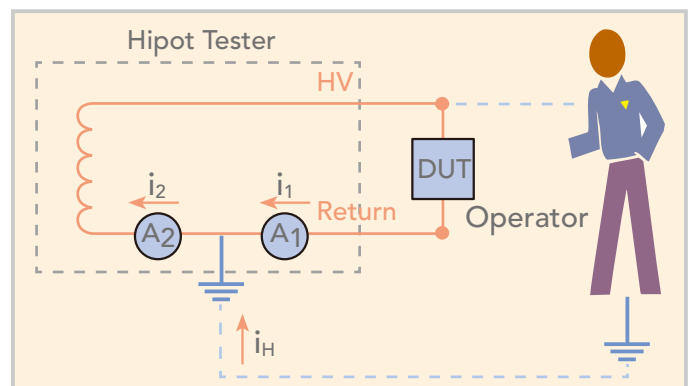

PANEL DESCRIPTION

19073

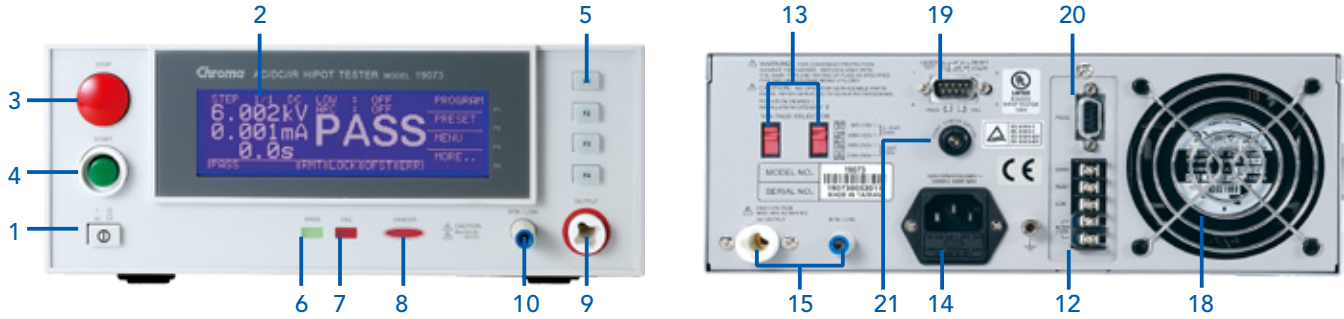

19053

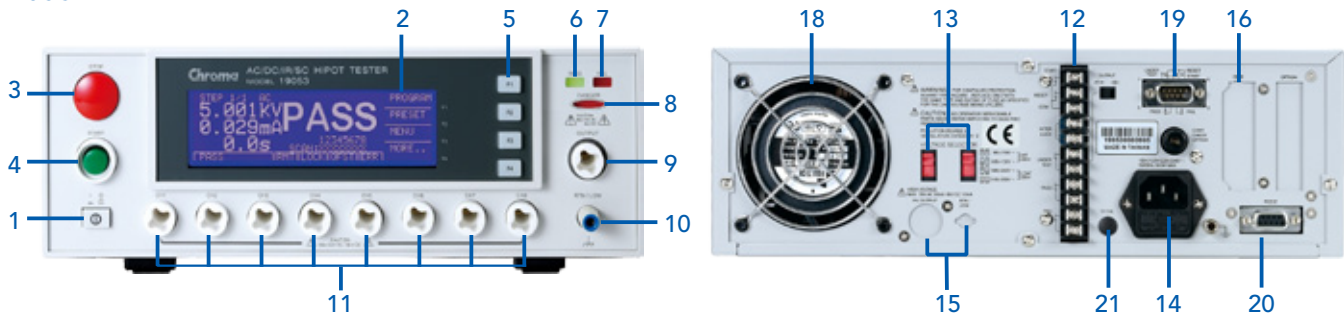

- | | | |
|--------------------------|---------------------------------------|-------------------------------------|
| 1. LINE Switch | 9. HV Output | 16. GPIB/Printer Interface (option) |
| 2. Window Display | 10. RTN/LOW | 17. Scan Interface (option) |
| 3. Stop Button | 11. 8 channels HV Output (19053 only) | 18. Fan |
| 4. Start Button | 12. Remote I/O | 19. Remote Interface |
| 5. Function Keys (F1~F4) | 13. LINE Voltage Selector | 20. RS-232 Interface |
| 6. Pass Indicator | 14. Power Cord Receptacle | 21. Continuity Test O/P |
| 7. Fail Indicator | 15. Rear HV Output & RTN/LOW | |
| 8. Test Indicator | | |

APPLICATIONS

- Production test for appliances, instruments and information technology equipment in compliance with UL, IEC, TUV and other standards such as EN 60335, EN 60950, EN 61010, CSA C22.2 No.1010.1, UL 3111 and UL 1950
- Transformer electrical safety tests
- Various electronic components tests

ORDERING INFORMATION

19071 : ACWV Hipot Tester
 19073 : ACWV / DCWV / IR Hipot Tester
 A190701 : Remote control box
 A190702 : 40kV test probe
 A190704 : Start switch
 A190706 : 19" rack mount kit
 A190708 : ARC verification fixture

19052 : Hipot Tester (ACWV / DCWV / IR)
 19053 : Hipot Tester (ACWV / DCWV / IR / 8CH SCAN)
 19054 : Hipot Tester (ACWV / DCWV / IR / 4CH SCAN)
 A190344 : HV gun (SP02)
 A190508 : GPIB interface
 A190512 : Auto control TR. scan box (Model 19053 only)
 A190517 : 19" rack mount kit
 A190518 : Hipot tester software for 19050 series

SPECIFICATIONS

Model	19071	19073	19052	19053	19054	
Mode	ACVV	ACVV / DCVV / IR	ACVV / DCVV / IR	ACV / DCV / IR / SCAN		
Scanner Unit	-	-	-	8 ports, \pm phase	4 ports, \pm phase	
Withstanding Voltage Test						
Output Voltage	AC : 0.05 ~ 5kV, DC : 0.05 ~ 6kV					
Load Regulation	\leq (1%+5V)					
Voltage Resolution	2V					
Voltage Accuracy	\pm (1% of reading + 5 counts)					
Cutoff Current	AC : 0.1~20mA	AC : 0.1mA ~ 20mA DC : 0.01mA ~ 5mA		AC : 0.1 ~ 30mA, DC : 0.01 ~ 10mA		
Current Resolution	AC : 1 μ A, DC : 0.1 μ A					
Current Accuracy	\pm (1% of reading + 5 counts)					
Output Frequency	50Hz / 60Hz					
Test Time	0.3 ~ 999 sec., continue					
Ramp Time	0.1 ~ 999 sec., off					
Fall Time	0.1 ~ 999 sec., off					
Dwell Time	0.1 ~ 999 sec., off					
Waveform	Sine wave					
Insulation Resistance						
Output Voltage	-			DC : 0.05 ~ 1kV		
Voltage Resolution	-			2V		
Voltage Accuracy	-			\pm (1% of reading + 5 counts)		
IR Range	-	1M Ω ~ 50G Ω		1M Ω ~ 10G Ω		
Resistance Accuracy	\geq 500V	1.00M Ω ~ 25.00M Ω	-		\pm (5% of reading + 2% of full scale)	
		22.0 M Ω ~ 250.0M Ω	-	\pm (4% of reading + 5 counts)	\pm (5% of reading + 2% of full scale)	
		0.220G Ω ~ 1.000G Ω	-		\pm (5% of reading + 2% of full scale)	
		1.000G Ω ~ 2.500 G Ω	-	\pm (7% of reading + 5 counts)	\pm (5% of reading + 2% of full scale)	
	\leq 500V	2.20G Ω ~ 10.00G Ω	-	\pm (7% of reading + 5 counts)	\pm (15% of reading + 1% of full scale)	\pm (15% of reading + 1% of full scale)
		10.00G Ω ~ 50.00G Ω	-	\pm (12% of reading + 5 counts)	\pm (15% of reading + 1% of full scale)	\pm (15% of reading + 1% of full scale)
		0.10 M Ω ~ 25.00M Ω	-		\pm (10% of reading + 2% of full scale)	\pm (10% of reading + 2% of full scale)
		22.0M Ω ~ 250.0M Ω	-	\pm (7% of reading + 5 counts)	\pm (10% of reading + 2% of full scale)	\pm (10% of reading + 2% of full scale)
		0.220 G Ω ~ 1.000G Ω	-		\pm (15% of reading + 1% of full scale)	
Flashover (ARC) Detection						
Setting Mode	Programmable setting					
Detection Current	AC : 1mA ~ 20mA	AC : 1mA ~ 20mA DC : 1mA ~ 5mA		AC : 1mA ~ 15mA ; DC : 1mA ~ 10mA		
Secure Protection Function						
Fast Output Cut-off	0.4ms after NG happen					
Ground Fault Interrupt	0.5mA \pm 0.25mA AC, ON/OFF					
Panel Operation Lock	Present password					
Continuity Check	1~5 Ω \pm 0.2 Ω , ON/OFF			1 Ω \pm 0.2 Ω , ON/OFF		
GO/NG Judgment Window						
Indication, Alarm	GO : Short sound, Green LED ; NG : Long sound, Red LED					
Data Hold	Least tests data memories					
Memory Storage	10 tests setups with 60 steps pre setup			99 steps or 99 groups for total 500 memory		
Remote & Interface						
Remote control	Input : Start, Stop, Interlock (at 11 pin terminal block only) Output : Under test, Pass, Fail					
Communication Interface	RS485 (option)			RS232 (standard), GPIB (option)		
General						
Operation Environment	Temperature : 0 $^{\circ}$ C~40 $^{\circ}$ C ; Humidity : 15% to 95% R.H @ \leq 40 $^{\circ}$ C					
Power Requirements	100V/120V/220V/240V (AC \pm 10%), 50/60Hz					
Power Consumption	300W			500W		
Dimension (W x H x D)	270x105x350 mm/10.63x4.13x13.78 inch			320 x 105 x 400 mm/12.6x4.13x15.75 inch		
Weight	11 kg / 24.23 lbs			Approx. 15.4 kg / 33.92 lbs		
Certification	UL, TUV, CE			UL, TUV, CE	CE	UL, TUV, CE

*All specifications are subject to change without notice.

Get more product & distributor information in Chroma ATE APP



iOS



Android

Search Keyword

19070 or 19050

HEADQUARTERS
CHROMA ATE INC.
66 Huaya 1st Road,
Guishan, Taoyuan
33383, Taiwan
T +886-3-327-9999
F +886-3-327-8898
www.chromaate.com
info@chromaate.com

U.S.A.
CHROMA SYSTEMS
SOLUTIONS, INC.
19772 Pauling,
Foothill Ranch,
CA 92610
T +1-949-600-6400
F +1-949-600-6401
www.chromausa.com
sales@chromausa.com

EUROPE
CHROMA ATE EUROPE B.V.
Morsestraat 32,
6716 AH Ede,
The Netherlands
T +31-318-648282
F +31-318-648288
www.chroma.eu.com
sales@chroma.eu.com

CHROMA GERMANY GMBH
Südtiroler Str. 9, 86165,
Augsburg, Germany
T +49-821-790967-0
F +49-821-790967-600
www.chroma.eu.com
sales@chroma.eu.com

JAPAN
CHROMA JAPAN
CORP.
888 Nippa-cho,
Kouhoku-ku,
Yokohama-shi,
Kanagawa,
223-0057 Japan
T +81-45-542-1118
F +81-45-542-1080
www.chroma.co.jp
info@chroma.co.jp

KOREA
CHROMA ATE
KOREA BRANCH
3F Richtogether
Center, 14,
Pangyojeok-ro 192,
Bundang-gu,
Seongnam-si,
Gyeonggi-do
13524, Korea
T +82-31-781-1025
F +82-31-8017-6614
www.chromaate.co.kr
info@chromaate.com

CHINA
CHROMA ELECTRONICS
(SHENZHEN) CO., LTD.
8F, No.4, Nanyou Tian
Center, 14,
An Industrial Estate,
Shenzhen, China
T +86-755-2664-4598
F +86-755-2641-9620
www.chroma.com.cn
info@chromaate.com

SOUTHEAST ASIA
QUANTEL PTE LTD.
(A company of Chroma Group)
46 Lorong 17 Geylang # 05-02
Enterprise Industrial Building,
Singapore 388568
T +65-6745-3200
F +65-6745-9764
www.quantel-global.com
sales@quantel-global.com