

## MODEL 19311 SERIES

### KEY FEATURES

- Max. output voltage: 6kV  
(Depends on DUT's capacitance)
- Pulse interval: 30ms ~ 3000ms
- 8 types of judgements:
  - Area
  - Differential Area
  - Flutter
  - Laplacian
  - 1st Peak Voltage (V1)
  - 3rd Peak Voltage (V3)
  - Peak Ratio
  - $\Delta$  Peak%
- Contact Check
- Breakdown Voltage Mode (BDV Mode)
- Sampling rate: 200MHz
- Support up to 25 channels for scanning test (19311-10 with A190362 option)
- User interface :
  - English
  - Traditional chinese
  - Simplified chinese
- Support USB flash driver
  - Waveform, test conditions & Test results storage
  - Screen capture
  - Backup files
- Graphical color display
- Standard remote interface : LAN, USB & RS232

## BATTERY CELL SURGE TESTER MODEL 19311 SERIES

The Chroma 19311 series Battery Cell Surge Tester, is designed for testing the insulation quality between the positive and negative plates of the lead-acid battery cell. This is done by applying a high voltage surge/impulse before the electrolyte injection. Its output voltage can reach up to 6kV. It also has four terminal measurement and 200MHz sampling rate. The Chroma 19311 series has single channel (19311) and multi-channel (19311-10) tester.

The 19311-10 has 10 channels, which can test up to 9 battery cells via scanning test, with a single unit. It can support up to 25 channels for testing up to 24 cells in a sequence by connecting with an external scanner (A190362). The test speed of the multi-cell scanning test by 19311-10 is extremely efficient, saving test time, and decreasing labor costs. It also increases the production capacity of the production line.

Testing the lead-acid battery cell with a high voltage surge before the electrolyte injection checks the insulation distance and the insulation quality between the positive and negative plates, determines the separator between the positive and negative plates, and identifies whether the positive and negative plates are not short together. The surge test can decrease the defective rate of the lead acid battery production and increase the insulation quality of the lead-acid battery cell.

Chroma 19311 series can analyze the differences of the insulation quality from the resonant waveform. There are 8 types of judgements for analysis: Area, Diff-Area, Flutter, Laplacian, V1, V3, Peak Ratio and  $\Delta$  Peak%.

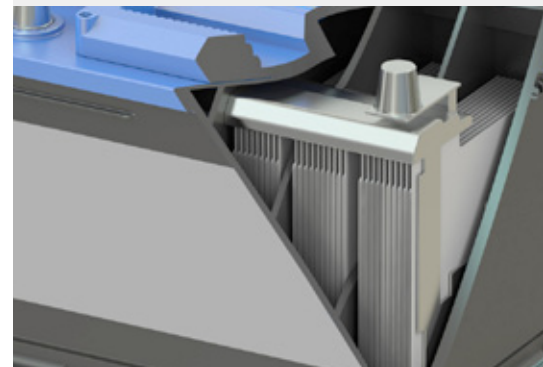

**Chroma**

## SURGE TEST

The surge test applies a "non-destructive", short period and low energy impulse voltage on a lead-acid battery cell. During the surge test, the lead-acid battery cell resonates with the internal inductor because there is an internal inductor in the 19311/19311-10. The 19311/19311-10 can judge if the lead-acid battery cell is a good cell or not by analyzing the resonant waveform or comparing the test waveform with the sample waveform. The main purposes of testing the lead-acid battery cell by a high voltage surge test before the electrolyte injection are checking whether the insulation distance between the positive and negative plates is enough, checking whether the insulation quality between the positive and negative plates is good, checking whether the separator between the positive and negative plates exists, and checking whether the positive and negative plates are not short together. Detecting the defect battery cell before the electrolyte injection can decrease the defective rate of the lead-acid battery production. After the switch turns off, the decrease of the peak voltage represents the insulation quality of the battery cell.

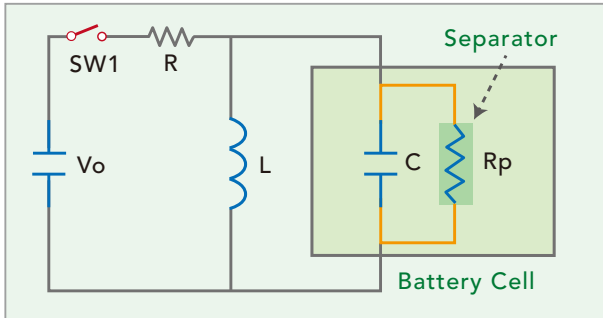

Vo : Internal Output Voltage  
 R : Internal Resistor  
 L : Internal Inductor  
 SW1 : Switch  
 C : Equivalent Capacitance  
 Rp : Equivalent Parallel Resistance (Separator)

Equivalent Circuit Diagram

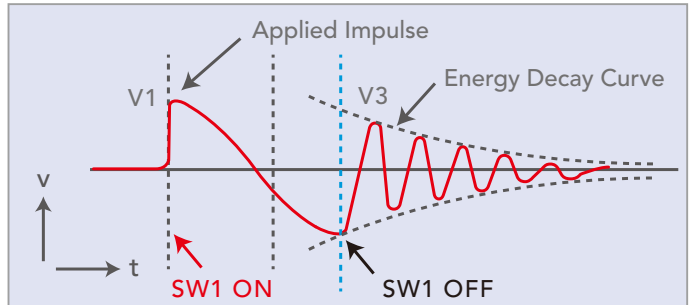

**SW1 ON (WV Test)**  
 - Area  
 - Differential Area  
 - Flutter  
 - Laplacian  
 - V1

**SW1 OFF (Rp/Q Check)**  
 - V3  
 - Peak Ratio  
 -  $\Delta$ Peak %

Test Waveform Diagram

## 8 TYPES OF JUDGEMENT FUNCTIONS

### Area

Area, which is comparing the difference of the total area between the test waveform and the sample waveform, can be used to check whether or not the insulation between the positive and negative plates is poor or whether or not the separator exists between the positive and negative plates. Area represents the insulation status of the lead-acid battery cell. When the insulation between the positive and negative plates is poor, insulation distance between the positive and negative plates is too short, or the separator between the positive and negative plates does not exist, if the electric field intensity/voltage is high enough, the discharge occurs. This energy released causes the area size of the test waveform to become smaller than the area size of the sample waveform.

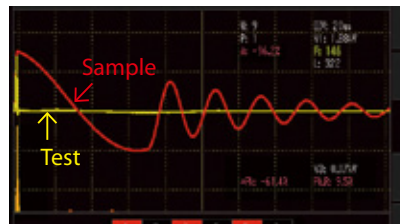

Short Battery Cell

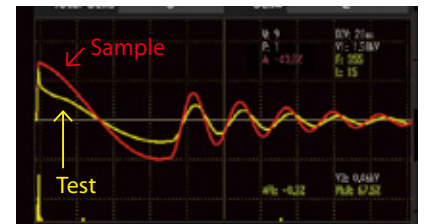

Moist Battery Cell

### Differential Area

Differential Area, which compares the area created between the test waveform and the sample waveform with the total area of the sample waveform, can be used to check the difference of the battery cell's capacitance. When the capacitance of the battery cell is larger, the resonant frequency is lower. Therefore, when the capacitance of the battery cell is smaller, the resonant frequency is higher.

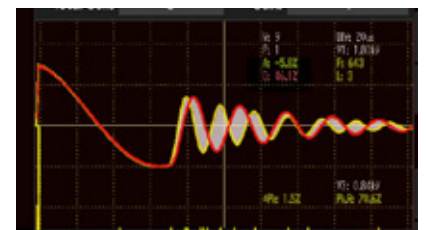

Differential Area

### Flutter

Flutter, which is a total value of the waveform that is calculated by using the 1st derivative of differential equation, can be used to do the contact check. When the probe does not contact to the battery cell, the capacitance is much smaller than the capacitance with a good contact, so the resonant frequency becomes very high after the switch turns off, which causes the value of Flutter to become larger. Therefore, Flutter can detect whether or not the probe contacts the battery cell.

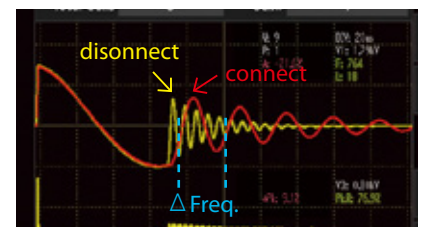

Contact Fail

## APPLICATIONS

### Laplacian

Laplacian, which is calculated by using the 2nd derivative of differential equation, can be used to check the occurrence of the small discharge. It can detect the rapid changes in the test waveform caused by the small discharge during the surge test.

### V1

V1 is the 1st peak voltage of the resonant waveform. When the insulation is poor or the separator does not exist between the positive and negative plates, if the electric field intensity/voltage is high enough, the discharge occurs. This energy released causes the 1st peak voltage (V1) to be smaller than the good battery cell.

### V3

V3 is the 3rd peak voltage of the resonant waveform. When the insulation is poor or the separator does not exist between the positive and negative plates, if the electric field intensity/voltage is high enough, the discharge occurs. This energy released causes the 3rd peak voltage (V3) to be smaller than the good battery cell. When the insulation quality of the test battery cell is not good, because the energy loss is more, the 3rd peak voltage (V3) is smaller than the good battery cell.

### Peak Ratio

Peak Ratio, which is the ratio between the 5th peak voltage (V5) and the 3rd peak voltage (V3) of the waveform, can be used to check the insulation quality between the positive and negative plates of the lead-acid battery cell. When the insulation quality is worse or the parallel resistance (Rp) is less, because the energy loss is more, the voltage of the 5th peak voltage becomes smaller. Therefore, the peak ratio of the bad insulation quality is less than the peak ratio of the good insulation quality. The value of the peak ratio represents the status of the insulation quality between the positive and negative plates of the lead-acid battery cell.

### Δ Peak %

ΔPeak% can be used to check whether or not the insulation quality between the positive and negative plates of the lead-acid battery cell is close to the golden sample. ΔPeak% is the difference of the peak ratio between the test waveform and the sample waveform. This can be used to sort out the battery cell whose insulation quality is not close to the golden sample. When the insulation quality of the test battery cell and the insulation quality of the golden sample are the same, because the peak ratio of the test waveform and the peak ratio of the sample waveform are also the same, the ΔPeak% is 0%. When the insulation quality of the test battery cell is worse than the insulation quality of the golden sample, because the peak ratio of the test waveform is less than the peak ratio of the sample waveform, the ΔPeak% is a negative number.

$$\text{Peak Ratio} = \frac{V_5}{V_3} \times 100\%$$

$$\Delta \text{Peak \%} = \text{Peak Ratio}_{\text{Test}} - \text{Peak Ratio}_{\text{Sample}}$$

### Contact Check

Contact Check function checks whether the DUT is connected or not by the difference of the frequency. When the battery cell is disconnected, the capacitance is much smaller than the capacitance with the battery cell is connected, so the resonant frequency becomes very high. This is why the difference of the frequency can be used for the contact check. The operators can adjust the sensitivity of the contact check to meet their own need. The sensitivity of the contact check can be increased by increasing the limit or can be decreased by decreasing the limit.

### Breakdown Voltage (BDV Mode)

19311 Series has the breakdown voltage mode for analysis, which can set the start voltage and the end voltage. While the test voltage increases from the start voltage to the end voltage, it checks whether or not the values of Area, Laplacian and Peak Ratio exceed the limits for finding the maximal withstand voltage of the battery cell. The research and development engineer can use the BDV mode to analyze and research the lead-acid battery cell, and establish the test voltage of the surge test for the production.

### 10/25 Channels Scanning Test

19311-10 has 10 channels in one single unit. It can test up to 9 cells (max.) in one test sequence. It also can expand the channels to 25 (max.) with a Scan Box (A190362), which can test up to 24 cells (max.) in one test sequence.

### Screenshot

The operator can use the hot key to screenshot the screen display. The screenshot file will be stored into the USB flash drive that is plugged in.

### Export

The operator can use the Export function to export the data of the current test result into the USB flash drive that is plugged in, and analyze the data of the current test result. The file storage format is in CSV (Comma Separated Values) format.

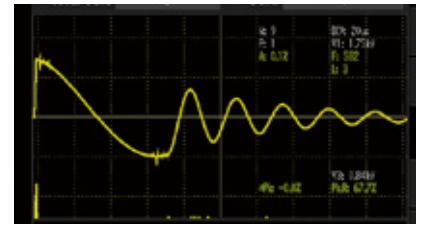

Electrical Discharge

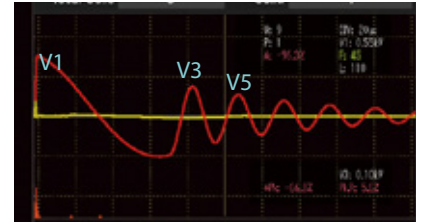

Peak Voltages Diagram



Test Results (Waveform display)

Test Results (Table display)

## PANEL DESCRIPTION

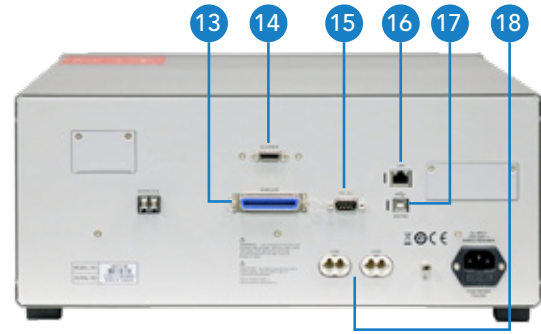
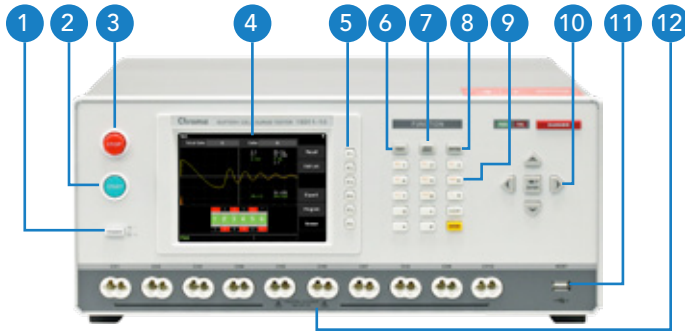

- |                      |                               |   |
|----------------------|-------------------------------|---|
| 1. Power Switch      | 7. Main Index                 | 13. HANDLER Interface : Automated Production Line         |
| 2. Start Button      | 8. System                     | 14. Scanner Control Interface : External Scanner A190362  |
| 3. Stop Button       | 9. Keypad                     | 15. RS-232 Interface : Remote Control                     |
| 4. LCD Color Display | 10. Direction Keypad          | 16. LAN Interface : Remote Control                        |
| 5. Function Keys     | 11. USB Flash Drive interface | 17. USB Interface : Remote Control                        |
| 6. Test Mode         | 12. Test Terminals/Channels   | 18. Scanner Channel Connection : External Scanner A190362 |

## SPECIFICATIONS

Model	19311	19311-10
Output Voltage, Step	0.10 kV~6.00 kV, 0.01 kV *	
Test Voltage	≥ 3.00kV @ 50nF	
Sampling Rate	200MHz	
Width Range	11 Range : 1~11 & Auto	
Pulse Number	1~32 & Continue	
Pulse Interval	30ms ~ 3000ms for ≤ 4kV 60ms ~ 3000ms for > 4kV 70mS ~ 3000ms for continue (Screen On) 30mS ~ 3000ms for continue (Screen Off)	
Channels	1	10
Screen Display Resolution	640 x 480 dots (VGA)	
Waveform Display Range	color display 512 x 256 dots	
Judgment	Area, Differential Area, Flutter, Laplacian, V1, V3, Peak Ratio, Δ Peak %	
Test Time for 6 cells	Fastest : ≤ 1.2s	
<b>Electrical Hazard Protection Function</b>		
Key Lock	Yes (password control)	
Interlock	Yes	
Indication	GO : Green LED ; NG : Red LED	
Alarm	GO : Short Beep ; NG : Long Beep	
Interfaces	Handler, RS-232, USB , LAN(Ethernet)	
<b>General</b>		
Operation Environment	Temperature : 0°C ~ 40°C ; Humidity : 15% to 90% ; R.H @ ≤ 40°C	
Power Consumption	No load : <150VA Rated load : <400VA	
Power Requirements	100~240Vac, 50 / 60Hz	
Dimension (W x H x D)	177 x 428 x 500 mm / 6.97 x 16.85 x 19.69 inch	
Weight	26 kg / 57.32 lbs	

Note \* : Chroma recommends to use the standard test cable (≤ 3 meters) for the surge test. The test cable, which is longer than 3 meters or not the standard test cable from Chroma, may affect the test waveform and the test result.

All specifications are subject to change without notice. Please visit the official website for the latest specifications.

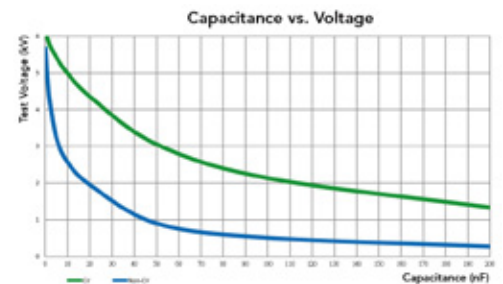

## ORDERING INFORMATION

- 19311 : Battery Cell Surge Tester
- 19311-10 : Battery Cell Surge Tester (10 channels)
- A190362 : 16-channel 4-wire HV External Scanning Box
- A190364 : 4-wire test cable with bare wire (1.5m)
- A190365 : 4-wire test cable with bare wire (3m)

Get more information by downloading Chroma ATE Solutions APP



iOS





Android

Search Keyword

19311

HEADQUARTERS  
CHROMA ATE INC.  
66 Huaya 1st Road,  
Guishan, Taoyuan  
33383, Taiwan  
T +886-3-327-9999  
F +886-3-327-8898  
www.chromaate.com  
info@chromaate.com

U.S.A.  
CHROMA SYSTEMS  
SOLUTIONS, INC.  
19772 Pauling,  
Foothill Ranch,  
CA 92610  
T +1-949-600-6400  
F +1-949-600-6401  
www.chromausa.com  
sales@chromausa.com

EUROPE  
CHROMA ATE  
EUROPE B.V.  
Morsestraat 32,  
6716 AH Ede,  
The Netherlands  
T +31-318-648282  
F +31-318-648288  
www.chroma.eu.com  
sales@chroma.eu.com

CHROMA GERMANY GMBH  
Südtiroler Str. 9, 86165,  
Augsburg, Germany  
T +49-821-790967-0  
F +49-821-790967-600  
de.chromaate.com  
sales@chroma.eu.com

JAPAN  
CHROMA JAPAN  
CORP.  
888 Nippa-cho,  
Kouhoku-ku,  
Yokohama-shi,  
Kanagawa,  
223-0057 Japan  
T +81-45-542-1118  
F +81-45-542-1080  
www.chroma.co.jp  
info@chroma.co.jp

KOREA  
CHROMA ATE  
KOREA BRANCH  
3F Richtogether  
Center, 14,  
Pangyoeyeok-ro 192,  
Bundang-gu,  
Seongnam-si,  
Gyeonggi-do  
13524, Korea  
T +82-31-781-1025  
F +82-31-8017-6614  
www.chromaate.com  
erica.shih@chromaate.co.kr

CHINA  
CHROMA ELECTRONICS  
(SHENZHEN) CO., LTD.  
8F, No.4, Nanyou Tian  
An Industrial Estate,  
Shenzhen, China  
T +86-755-2664-4598  
F +86-755-2641-9620  
www.chroma.com.cn  
info@chromaate.com

SOUTHEAST ASIA  
QUANTEL PTE LTD.  
(A company of Chroma Group)  
46 Lorong 17 Geylang # 05-02  
Enterprise Industrial Building,  
Singapore 388568  
T +65-6745-3200  
F +65-6745-9764  
www.quantel-global.com  
sales@quantel-global.com